

- (A) 2" Drainage manifold
Colector drenaje 2"
- (B) 8" Inlet manifold - DIN 2576 Flanged
Colector entrada 8" - Brida DIN 2576
- (C) 8" Outlet manifold - DIN 2576 Flanged
Colector salida 8" - Brida DIN 2576

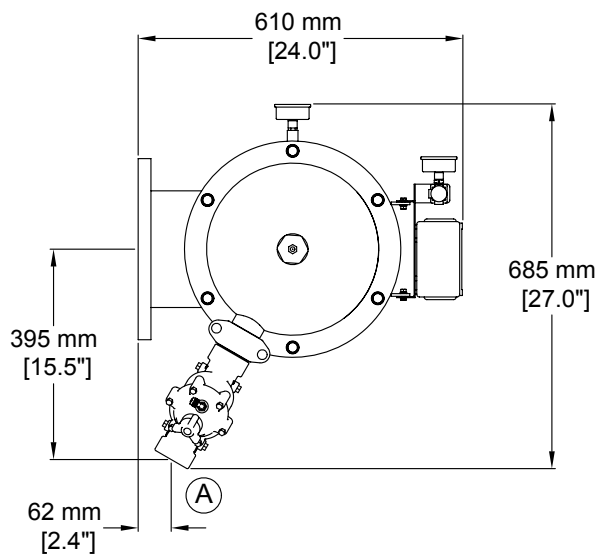

AZUD

SCALE
S/E
A4 FORMAT

AZUD LUXON LCA 4800 M/8

RESPONS.: M. Martínez

REVISION: 03

UNITS: mm [in]

DATE: 05/06/2017